

	Day 1	Day 2	Day 3	Day 4	Day 5
Math (45 Minutes)	Easter Monday	Activities: Area of Composite Figures (Lesson 10.4 Reteach) and Area of Composite Figures (Lesson 10.4 Additional Practice)	Khan Academy Video: "Slicing a Rectangular Prism" Activity: Describe and Analyze Sections of Prisms and Pyramids (11.1 Reteach)	ck-12 Videos: "Surface Area of a Cube or Cuboid – Overview" "Surface Area of a Triangular Prism" Activity: Derive and Apply Formulas for Surface of Cubes and Right Prisms (11.2 Reteach)	Read from ck-12: "Volume of Rectangular Prisms" Watch embedded video and do review problems
Physical Education (15 Minutes)		Physical Activity – <ul style="list-style-type: none"> Go for walk/run YouTube – Kidz Bop Dance YouTube – Kids Workout 	Physical Activity – <ul style="list-style-type: none"> Go for walk/run YouTube – Kidz Bop Dance YouTube – Kids Workout 	Physical Activity – <ul style="list-style-type: none"> Go for walk/run YouTube – Kidz Bop Dance YouTube – Kids Workout 	Physical Activity – <ul style="list-style-type: none"> Go for walk/run YouTube – Kidz Bop Dance YouTube – Kids Workout
English Language Arts (60 Minutes)		Reading Comprehension: Wit and Wisdom Lesson 4 part 2 Reading Comprehension: Commonlit: "Theseus and the Minotaur" text and questions (Print copies available at meal sites). Springboard Grammar: Active and Passive voice (Print copies available at meal sites) Grammar Practice: Click Here for Khan Academy	Reading Comprehension: Wit and Wisdom: Lesson 5 part 1 Reading Comprehension: Commonlit "The Underground Railroad" text and questions And paired text questions from "Theseus and the Minotaur" and "The Underground Railroad" (Print copies available at meal sites)	Reading Comprehension: Wit and Wisdom: Lesson 5 part 2 Vocabulary Practice: membean.com/enroll?t=CLEVMID and enter code: CLEVMID Membean can be accessed from any device – including a smartphone. Follow directions to enroll in your class, and answer the "calibration" questions to get your own personalized word list.	Reading Comprehension: Wit and Wisdom: Module 4 Lesson 1 Vocabulary Practice: Click Here for Membean.com and continue to work with your personalized word list. Writing Practice: Writable Assignment 2 Select: Argument Skills Activity Middle School – Provide a conclusion writing. (Print

Weekly Enrichment Plan: Week of April 13

Grade: 7

<p>Art (15 Minutes)</p>		<p>Music Listen to a piece of music. Reflect on how this new music makes you feel. Do you like it? Why or why not?</p>	<p>Art Free draw/paint/build Create something new from imagination or take inspiration from objects you see every day.</p>	<p>Music Listen to a piece of music. Reflect on how this new music makes you feel. Do you like it? Why or why not?</p>	<p>Art Free draw/paint/build Create something new from imagination or take inspiration from objects you see every day.</p>
	<p>Independent Novel Reading: Novels available at meal sites Read for 20 minutes and spend 10 minutes answering the reading comprehension questions that you are able to each day. You can write a summary of what you read, write a critique or review, or call a friend and tell him or her about what you read as well.</p>	<p>Springboard Grammar: Parallelism (Print copies available at meal sites) Grammar Practice: Click Here for Khan Academy Independent Novel Reading: Novels available at meal sites Read for 20 minutes and spend 10 minutes answering the reading comprehension questions that you are able to each day. You can write a summary of what you read, write a critique or review, or call a friend and tell him or her about what you read as well.</p>	<p>Writing Practice: Writable Assignment 2 Select: Argument Skills Activity Middle School – Provide a conclusion writing. (Print copies also available) *This assignment will take more than 1 day Independent Novel Reading: Novels available at meal sites Read for 20 minutes and spend 10 minutes answering the reading comprehension questions that you are able to each day. You can write a summary of what you read, write a critique or review, or call a friend and tell him or her about what you read as well.</p>	<p>copies also available) *This assignment will take more than 1 day Independent Novel Reading: Novels available at meal sites Read for 20 minutes and spend 10 minutes answering the reading comprehension questions that you are able to each day. You can write a summary of what you read, write a critique or review, or call a friend and tell him or her about what you read as well.</p>	

<p>Science (30 Minutes)</p>		<p>Topic: Earth's Water <u>Water and It's Properties Activity</u></p> <p>Read the text below and then complete the Symbol and Metaphor Handout</p> <p>Political Cartoons Political cartoons are expressions of opinions that use all sorts of emotional appeals and other techniques to persuade others to accept those opinions.</p>	<p>Topic: Earth's Water <u>Ocean Currents Activity</u></p> <p>Click Here to read and complete Visual Distortion Worksheet</p>	<p>Topic: Earth's Water <u>Human Impact on Water Mix and Match Activity</u></p> <p>Click Here to read and complete Iron Words & Images Worksheet</p>	<p>Topic: Earth's Water <u>Human Impact on Water Activity</u></p> <p>Read the following editorial in favor of social distancing. Do you agree with the article? Explain your answer. Social Distancing Required, Emotional Connections Needed</p>
<p>Social Studies (30 Minutes)</p>					
<p>Social Emotional Learning/ Reflection (15 Minutes)</p>		<p>Emotion Check-In Share your feelings with someone or journal about school being closed.</p>	<p>Self-Awareness Write a compliment to yourself and keep it to look at later.</p>	<p>Empathy & Communication Leave a kind note somewhere for a family member to find.</p>	<p>Self-Awareness Make a list of things for which you are grateful.</p>
<p>Student Daily Check-Off (check off each activity that you completed)</p>	<p><input type="checkbox"/> Math <input type="checkbox"/> English <input type="checkbox"/> Physical Ed. <input type="checkbox"/> Fine Arts <input type="checkbox"/> Science <input type="checkbox"/> Social Studies <input type="checkbox"/> SEL/Reflection</p>	<p><input type="checkbox"/> Math <input type="checkbox"/> English <input type="checkbox"/> Physical Ed. <input type="checkbox"/> Fine Arts <input type="checkbox"/> Science <input type="checkbox"/> Social Studies <input type="checkbox"/> SEL/Reflection</p>	<p><input type="checkbox"/> Math <input type="checkbox"/> English <input type="checkbox"/> Physical Ed. <input type="checkbox"/> Fine Arts <input type="checkbox"/> Science <input type="checkbox"/> Social Studies <input type="checkbox"/> SEL/Reflection</p>	<p><input type="checkbox"/> Math <input type="checkbox"/> English <input type="checkbox"/> Physical Ed. <input type="checkbox"/> Fine Arts <input type="checkbox"/> Science <input type="checkbox"/> Social Studies <input type="checkbox"/> SEL/Reflection</p>	<p><input type="checkbox"/> Math <input type="checkbox"/> English <input type="checkbox"/> Physical Ed. <input type="checkbox"/> Fine Arts <input type="checkbox"/> Science <input type="checkbox"/> Social Studies <input type="checkbox"/> SEL/Reflection</p>

Suggested Daily Schedule: Grades 6-8

Time	Activity
8:00 – 9:00 am	Wake up, make your bed, eat breakfast and get ready for an awesome day!
9:00 – 9:45 am	Mathematics
9:45- 10:00 am	Physical Activity
10:00– 10:45 am	English Language Arts – Reading Comprehension
10:45 – 11:00 am	15-Minute Break
11:00 – 11:15 am	Art
11:15 am – 12:00 pm	English Language Arts - Novel
12:00 – 1:00 pm	Lunch
1:00 – 1:30 pm	Science
1:30-1:45 pm	15-Minute Break
1:45-2:15 pm	Social Studies
2:15-2:30 pm	Social-Emotional Learning/Reflection

Family Suggestions

Parent Suggestions	Student Suggestions
<p>How can I support my student as a learner outside of school?</p> <ul style="list-style-type: none"> <input type="checkbox"/> Familiarize yourself with your child's learning calendar. <input type="checkbox"/> Encourage your child to do their best when completing tasks and assignments. <input type="checkbox"/> Contact your child's teacher or the district's homework hotline when you or your child have questions or need feedback. <input type="checkbox"/> Support your child in starting the daily work early in the day. Waiting until the late afternoon or evening to start work adds unnecessary stress and creates missed opportunities for collaboration and feedback. <input type="checkbox"/> Remind your child to take frequent breaks to stay focused. <input type="checkbox"/> Consider designating a dedicated workspace to maximize time on task and facilitate learning. 	<p>How can I continue learning outside of school?</p> <ul style="list-style-type: none"> <input type="checkbox"/> Complete work on your suggested learning calendar. <input type="checkbox"/> Put in your best effort when completing tasks and assignments. <input type="checkbox"/> Ask an adult to contact your teacher when you need help. Teachers are available via e-mail, your school's online learning program or on the district's homework hotline. <input type="checkbox"/> Let your teacher know if you have access to a phone or computer. <p>How can I stay organized?</p> <ul style="list-style-type: none"> <input type="checkbox"/> Start your work early. Waiting until the late afternoon or evening to start work adds unnecessary stress and creates missed opportunities for collaboration and feedback. <input type="checkbox"/> Take short breaks to increase focus and stay motivated to complete tasks on time. <input type="checkbox"/> Find a quiet place to complete your work.

<p>Individual Support</p>	<p>Individualizing Supports</p> <ul style="list-style-type: none"> • See “Individualizing Supports for Students” for more information on how to support your child at home with these assignments. • Additional materials are available online and at school meal sites: <ul style="list-style-type: none"> • “Specially Designed Instruction for Students with IEPs” packets with instructional routines that can be used at home to address students’ IEP goal areas. • Materials and resources for students with life skills needs and significant disabilities will also be available.
<p>English Language Learners</p>	<p>Enrichment Packet</p> <ul style="list-style-type: none"> • Daily language learning is important! The following links/resources are available for students to access daily. • ¡El aprendizaje diario de idiomas es importante! Los siguientes enlaces/recursos están disponibles para que los estudiantes accedan al aprendizaje diario de idiomas. • Kujifunza lugha ya kila siku ni muhimu! Viungo vifuatavyo/rasilimali vinapatikana kwa wanafunzi kupa ta mafunzo ya lugha ya kila siku. • दैनिक भाषा सिक्न महत्वपूर्ण छ! तलका लिंकहरू / स्रोतहरू विद्यार्थीहरूको लागि दैनिक भाषा सिक्ने पहुँचको लागि उपलब्ध छन्। <p>الموارد التالية متاحة للطلاب للوصول إلى تعلم اللغة اليومى.</p> <p>مهم ! الروابط /</p>

Individualizing Support for Students in Grades 6-12

For Students Who Struggle with Reading

Before Reading:

- For content area reading (nonfiction), provide some background information about the topic addressed in the text. The scholar can go online to look up information on the topic. Have scholar find resources in his/her preferred learning modality (videos, simplified text, activities) and summarize the new information learned.
- Look through the reading passage or book and look at pictures, graphics, and text features such as headings, captions, bolded words, etc. Discuss what you see and make a prediction about what you think will happen. During and after reading, adjust the prediction based on what you read.
- Look through the reading passage or book and identify difficult or unusual words. Have scholar practice decoding these words (reading them aloud). Provide meanings for these words. Create a vocabulary dictionary of these words to refer to later.

During Reading:

- **Accommodations:** Allow scholar to read aloud if they need to. Provide an audio recording of the text if available.
- **Chunking:** Read one paragraph or section at a time, and check for understanding by asking student to summarize or paraphrase what was read before moving to the next section.
- Make real-world connections (does the book remind you of something in your life? Another book, a movie, etc.)
- Stop and ask questions while reading. Ask questions with answers that can either be found in the reading or could be predictions about what might happen after the passage/story ends.

After Reading:

- For literature/fiction reading, have your scholar summarize what they read. Use the “5 W’s”
 - Who was the story/passage about?
 - What was the story/passage about? Make sure to include the main idea, some details, and how the story/passage ended
 - What did the character(s) learn?
 - What would be a good title for the story/passage? If one is provided already, what would be a different title you would give the story/passage?
 - When did the story/passage occur? This would be most important for informative and historical passages
 - Where did the story/passage occur?
 - Why? This can be many things, why did a specific character act in a certain manner? Why was a decision made? etc.
 - How? If there was a problem discussed ask how your scholar would have solved the problem differently, or how did that make you feel?
- For nonfiction reading/content area reading, have your scholar summarize what he/she has learned from the text and how he/she would apply the learning to real life.
- Allow an “open book” policy. Make sure that the scholar shows exactly where in the text he/she is getting the information to answer whatever question has been posed.

For Students Who Struggle with Written Assignments

- Have scholar dictate assignments into a phone's "notes" app or computer with speech-to-text technology. Most speech-to-text will also respond to commands to add punctuation (by saying "comma," "period," etc.). Student can then print out their writing, or copy it into their own handwriting.
- Write one sentence at a time, then have someone read it aloud to make sure it makes sense.
- Provide examples of quality writing that meets the task criteria.
- Accept a written assignment that is shorter than what is expected, as long as the task criteria are met.

For Students Who Struggle with Math Assignments

- Find a video of someone completing a similar task and have scholar watch it multiple times. Excellent resources for this are YouTube, Khan Academy, and LearnZillion.
- **Talk about math:** Have student explain a problem and its solution in mathematical terms. Have student teach a skill to another student. If they can teach it, they understand it.
- **Accommodations:** For tasks that require problem-solving, allow use of a calculator. Teach student how to use the calculator to accurately solve problems with multiple steps. Also provide access to anchor sheets for math procedures that may not be memorized, such as formulas.
- **Chunk assignments for easier completion/to ease frustration:** If there are 20 math problems to solve, complete 10 and take a break to move around. After the break go back and finish the other 10
- **Fractions:** use round food items to discuss fractions. Example: Cut a frozen pizza into 8 pieces and talk about pieces individually (1 piece is $\frac{1}{8}$) or in parts together (2 pieces is $\frac{2}{8}$ or $\frac{1}{4}$). Compare and contrast pieces of different sizes.
- **Graph paper:** use graph paper to organize work and problems, and to model mathematical situations visually.
- **Manipulatives:** any small item can be used as a manipulative to help with basic facts. Examples: coins, blocks, pieces of paper cut into smaller pieces. There are also virtual manipulatives online (Google "virtual math manipulatives").
- **Measurement, Money, and Time:**
 - Bake something and have your child measure out all of the ingredients for the recipe.
 - Have your child measure different items around the house and compare the sizes (What is bigger? What is smaller? How many ___ does it take to measure the couch?)
 - Take a walk outside for a movement break. While walking have them time how long it takes to go for the walk and get back home. Pick something outside like houses and have them count how many they pass while walking. You can also practice skip counting while you walk (example: for each step you take count by 2s, or 5s, or 10s).
 - Create a store using items around your house. Label each item with a dollar amount and have your child "shop" in your store or have them act as the cashier and make change.
 - Create a schedule for the day with times attached. Start with times on the hour and then get progressively more difficult with times on the half hour and quarter hour. Give a specific time they can play a game or use tech. This will help work on math skills and will also help keep your child focused on different tasks throughout the day!
- **Reference materials:** create a number line, hundreds chart, or anchor charts (worked examples) to help with math calculation, counting, and problem-solving.
- **Patterns:** use blocks or toys of similar colors to make a pattern. Example: 3 red Legos, 2 blue Legos, 3 yellow Legos, repeat.
- **Sorting:** Gather a group of toys and have your child sort them based on similar attributes (color, size, shape, etc.). Do the same with a set of books and have your child sort them based on fiction vs. nonfiction, type of book, etc.

- **Make it fun!** Practice math skills using games and things you might already have around the house and turn real-life activities into mathematical opportunities.
 - A deck of cards: each person draws 2 cards and then adds, subtracts, or multiply the numbers reflected on the cards.
 - Dice: can be used the same way as a deck of cards to work on basic facts or create multi-digit problems to solve.
 - Yahtzee: basic addition
 - Connect Four, Othello: problem solving, and strategic thinking
 - Puzzles: perfect for working on spatial awareness, which is key to geometry
 - Monopoly: have your child be the “banker” to work on money skills
 - Battleship: graphing coordinates
 - Uno: use numbers on cards to create calculation problems

For Students Who Struggle with Focus, Attention, and/or Study Skills

- Given scholar very clear written (or visual) directions of what to work on and what successful completion of the task looks like. Have scholar self-monitor whether or not he/she has completed all parts of the task.
- Use a timer, starting with a very brief amount of time (even 5-10 minutes is ok). After the timer “beeps,” provide student with a brief break (5 minutes) before continuing. Work to increase the amount of time for each work interval, up to 25 minutes.
- Provide a reward, such as a sticker or carrot, for every successful interval of on-task behavior.
- Only give one assignment or task at a time, but also provide scholar with a calendar or daily schedule to refer to so it is clear what to expect next.
- Have older students model study skills for younger children.

Name: _____ Class: _____

Theseus and the Minotaur

By E2BN.org
2006

In ancient Greece, people told myths to explain the ways of the world. Myths often portrayed brave heroes and vicious monsters. The ancient Greeks also believed in powerful gods who watched over Earth and intervened when they saw fit. In this particular myth, a prince from Greece's capital city of Athens travels by sea to another city, Crete, in order to fight a monster. As you read, take notes on how Theseus' actions and characteristics help drive the plot.

- [1] King Minos of Crete was a powerful man, feared by the rulers of the lands around him. When he demanded goods or men for his great armies, they felt they had to agree. When he demanded they send tributes¹ to honour him, they sent them without question. It was the only way they could stop him going to war with them. But his demands on Athens became too much for them to bear.

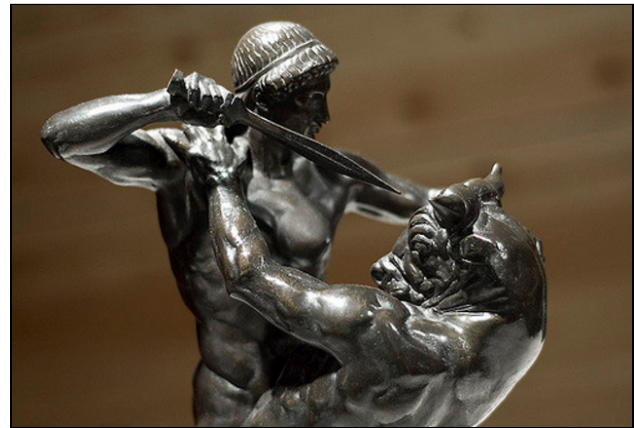

"Antoine-Louis Barye's 'Theseus Slaying The Minotaur'" by Timothy Vogel is licensed under CC BY-NC 2.0

King Minos had a great palace built for himself. Inside this palace, Minos had built a giant maze, a labyrinth, and, at the centre of the maze, he kept a terrifying creature – the Minotaur. Now this was no ordinary animal; it was a monster, half man and half bull.

It was powerful and savage,² and it loved to eat the flesh of the humans who had been shut into the labyrinth by King Minos. They would wander through the maze, completely lost, until at last they came face to face with the Minotaur. Not a great way to die, really.

As for Athens, Minos demanded that every year King Aegeus of Athens send him seven young men and seven young women.

- [5] "Why do we send these young people to Crete every year?" Theseus, the King's son, asked his father. "And why is it that none of them ever return?"

"Because if we did not send them, Minos would wage war on us and it is a war that we would not win," said King Aegeus. "And they do not return because they do not go to Crete as slaves. They go as food for the Minotaur."

"Father, this is terrible," shouted Theseus, "we cannot let this go on. We cannot sacrifice any more of our young citizens to this tyrant. When it is time to send the next tribute, I will go as one of them and I vow that it is the last time the Minotaur will be fed with the flesh of any of our people."

1. In this context, a tribute is a payment made by one state or ruler to another, especially as the price of peace, security, protection or to recognize authority
2. **Savage (adjective):** fierce, violent, or uncontrolled

Try as he might, his father could not persuade him to change his mind. Aegeus reminded him that every year, other young men had sworn to slay this terrible beast and they had never been seen again.

Theseus insisted that he understood the dangers but would succeed. "I will return to you, father," cried Theseus, as the ship left the harbour³ wall, "and you will be proud of your son."

- [10] "Then I wish you good luck, my son," cried his father, "I shall keep watch for you every day. If you are successful, take down these black sails and replace them with white ones. That way I will know you are coming home safe to me."

As the ship docked in Crete, King Minos himself came down to inspect the prisoners from Athens. He enjoyed the chance to taunt the Athenians and to humiliate⁴ them even further.

"Is this all your king has to offer this year?" he jeered. "Such puny⁵ creatures. Hardly even a snack for the mighty creature within the labyrinth. Anyway, let's get on with it. I am not a hard-hearted man, so I will let you choose which one goes first into the Minotaur's den. Who is it to be?"

Theseus stepped forward.

"I will go first. I am Theseus, Prince of Athens and I do not fear what is within the walls of your maze."

- [15] "Those are brave words for one so young and so feeble.⁶ But the Minotaur will soon have you between its horns. Guards, open the labyrinth and send him in."

Standing behind the king, listening, was his daughter, Ariadne. From the moment she set eyes on Theseus, Ariadne fell in love with him. As she listened to her father goading⁷ and taunting the young prince, she decided that she would help him. As he entered the labyrinth and the guards walked away, she called softly to him.

"Theseus, take this," she whispered. "Even if you kill the Minotaur, you will never find your way out again."

She threw him a great ball of string and he tied one end of it to the entrance. He smiled at her, turned and began to make his way into the maze, the string playing out behind him as he went.

Theseus walked carefully through the dark, foul-smelling passages of the labyrinth, expecting at any moment to come face-to-face with the creature. He did not have long to wait. Turning a corner, with his hands held out in front of him feeling his way, he suddenly touched what felt like a huge bony horn.

- [20] In an instant his world turned upside-down, quite literally. He was picked up between the Minotaur's horns and tossed high into the air. When he landed on the hard cold stone, he felt the animal's huge hooves come down on his chest. Every last breath seemed to be knocked out of him and he struggled to stay alive in the darkness.

3. A harbour is a place on the coast where ships may find shelter

4. **Humiliate (verb):** to make someone feel ashamed or foolish

5. **Puny (adjective):** small and weak

6. **Feeble (adjective):** lacking physical strength, especially due to age or illness

7. **Goad (verb):** to provoke or annoy in order to create a reaction

But Theseus was no ordinary man. He was the son of the King, he was brave and he was stubborn. As the Minotaur bellowed⁸ in his ear and grabbed at him with its hairy arms, Theseus found a strength which he did not know he possessed.

He grabbed the animal's huge horns, and kept on twisting the great head from side to side. As the animal grew weak, Theseus gave one almighty tug on the head, turning it almost right around. The creature's neck snapped, it gurgled its last breath and fell to the floor with an enormous thud.

It was over, he had done it. The Minotaur was dead. All he had to do was make his way out of... and then he realised the awful truth. In the struggle, he had let go of the string, his lifeline. Theseus felt all over the floor in the pitch darkness and kept thinking he had found it, only to realise that all he had was a long wiry hair from the Minotaur.

Despair⁹ set in and Theseus wondered if this was where his life would end, down in the dark, all alone, next to the stinking body. Then, his hand brushed a piece of string and, with a whoop of delight, he knew he had found the thread which would lead him back out. As he neared the entrance of the labyrinth, the darkness began to fade and he made out the figure of Ariadne, waiting for his return.

[25] "You must take me back to Athens with you," she cried, "My father will kill me when he finds out that I have helped you."

"But of course you must come with us," said Theseus, "it would be cruel to leave you here." Quickly and quietly, they unfurled¹⁰ the great black sails of their ship and headed for home.

"I cannot believe how my life has changed," said Ariadne, as they sailed across the calm seas towards Athens. "To think that I am free of my cruel father and that I will soon be married to a great prince."

"Married?" said Theseus, "Oh, yes, that will be... er... wonderful." But in truth, Theseus did not really find her attractive.

So, when their ship docked at an island on their way home, to collect fresh water, Theseus sent Ariadne off to find bread and fruit. The moment she was gone, he set sail and left her on the island. Now, you might think that this was a bad way to reward someone who had helped him and had saved him from certain death.

[30] The Gods clearly thought the same thing, for they had a further horror in store for him, as a punishment for his ungrateful treatment of the young girl.

In his haste¹¹ to get away, Theseus forgot to change his sails to white. King Aegeus, waiting on the headland, saw the ship approaching with its black sails flying in the wind.

"My son has failed and he is dead," he cried. And in despair, he flung himself from the cliff into the raging waters below. From that day on, the sea was named in memory of Theseus' father, and to this day, it is known as the Aegean Sea.

8. **Bellow (verb):** to shout in a loud or deep voice

9. **Despair (noun):** a feeling that everything is wrong and nothing will get better

10. to open something, like a flag, so that it is spread out

11. **Haste (noun):** speed or hurry, often made with urgency

"Theseus and the Minotaur", © 2006, East of England Broadband Network. Reprinted with permission, all rights reserved.

Text-Dependent Questions

Directions: For the following questions, choose the best answer or respond in complete sentences.

1. How does the author characterize Theseus in the story? Cite evidence from the text in your response.

2. PART A: How does the interaction between Theseus and King Minos in paragraphs 12-15 contribute to the plot as a whole?
 - A. It establishes King Minos as Theseus' central challenge in the labyrinth, setting up the king's battle with Theseus.
 - B. It creates an atmosphere of fear which remains with Theseus as he travels the labyrinth.
 - C. It helps the reader to fully visualize the new setting of Crete through the eyes of Theseus.
 - D. It further contrasts King Minos' villainous ways with Theseus' bravery, setting Theseus up as the hero.

3. PART B: Which later quote from the story confirms your answer to Part A?
 - A. "Theseus walked carefully through the dark, foul-smelling passages of the labyrinth, expecting at any moment to come face-to-face with the creature." (Paragraph 19)
 - B. "He was picked up between the Minotaur's horns and tossed high into the air. When he landed on the hard cold stone, he felt the animal's huge hooves come down on his chest." (Paragraph 20)
 - C. "As the Minotaur bellowed in his ear and grabbed at him with its hairy arms, Theseus found a strength which he did not know he possessed." (Paragraph 21)
 - D. "Theseus felt all over the floor in the pitch darkness and kept thinking he had found it, only to realize that all he had was a long wiry hair from the Minotaur." (Paragraph 23)

4. PART A: What does the word "tyrant" most closely mean as it is used in paragraph 7?
 - A. A person who runs a country
 - B. A leader who torments people
 - C. A soldier who is ready to fight
 - D. An innocent young citizen

5. PART B: Which quote from later in the story best supports your answer to Part A?
- A. "As the ship docked in Crete, King Minos himself came down to inspect the prisoners from Athens." (Paragraph 11)
 - B. "He enjoyed the chance to taunt the Athenians and to humiliate them even further." (Paragraph 11)
 - C. "Those are brave words for one so young and so feeble." (Paragraph 15)
 - D. "Standing behind the king, listening, was his daughter, Ariadne." (Paragraph 16)

6. How do the actions of Ariadne help further the plot? Cite evidence from the text in your response.

Discussion Questions

Directions: *Brainstorm your answers to the following questions in the space provided. Be prepared to share your original ideas in a class discussion.*

1. If it weren't for Ariadne, do you think Theseus would have been able to get out of the maze? Use details about the maze and Theseus' character to support your ideas.
2. How does the ending of the story change your opinion of Theseus' character? Do you think the gods should punish him? Why or why not?
3. The Ancient Greeks often told myths to explain how things came to be and to teach a lesson. What do we, as readers, learn from this myth about power? How can power corrupt people? Cite evidence from this text, your own experience, and other literature, art, or history in your answer.
4. In the context of this myth, what makes a hero? Cite evidence from this text, your own experience, and other literature, art, or history in your answer.

Lesson: Active and Passive Voice

Learning Targets

- Use verbs in the active and passive voice to achieve particular effects (e.g., emphasizing the actor or the action).
- Choose language that expresses ideas precisely and concisely, recognizing and eliminating wordiness and redundancy.

Active and Passive Voice

Voice tells you whether the subject of the verb performs or receives the action of the verb. If the subject performs the action, the verb is in **active voice**. In **passive voice**, the subject of the verb receives the action or is the object of the action.

Active voice: The girl **sings** a song. [The subject, *girl*, performs the action of singing.]

Passive voice: The song **is sung** by the girl. [The subject, *song*, does not perform the action of singing. It is the object of the action, which means that it receives the action.]

A verb in the passive voice includes a form of the verb *be*, a past participle of a verb, and any needed helping verbs. Here are examples of sentences in each tense, showing active-voice and passive-voice verbs.

Tense	Passive Voice	Active Voice
Present	The song is sung . The songs are sung .	The girl sings the song. The girls sing the song.
Past	The song was sung . The songs were sung .	The girl (or girls) sang the song.
Future	The song (or songs) will be sung .	The girl (or girls) will sing the song.
Present Perfect	The song has been sung . The songs have been sung .	The girl has sung the song. The girls have sung the song.
Past Perfect	The song (or songs) had been sung .	The girl (or girls) had sung the song.
Future Perfect	The song (or songs) will have been sung .	The girl (or girls) will have sung the song.

Active voice is usually more direct and clear. In most sentences, you should use active voice. However, you may use passive voice when you want to emphasize the action or the recipient of the action, or when you do not know who performed the action. You may also use passive voice to avoid pointing fingers or naming names.

Active voice: Sara Jones **broke** that vase last night.

Passive voice: That vase **was broken** last night.

Use the voice that best achieves your purpose with the fewest words.

Wordy and awkward: By then, the question **will have been asked** by the students and the answer **will have been heard** by them.

Better: By then, the students **will have asked** the question and **heard** the answer.

Check Your Understanding

Revise the following sentences, changing passive-voice verbs to active-voice verbs.

EXAMPLE: The energy was captured by the windmills.

The windmills **captured the energy**.

1. The kayaks had been loaded onto the car by Mark.
2. The trip to the store was made by Michael.
3. Most of the cooking was done by the adults.
4. Games were organized by Elaine, Nichole, and the kids.
5. What will have been done by Ranjan and Abby?

Name: _____ Class: _____

The Underground Railroad

By USHistory.org
2016

In the 1850's and 1860's, the United States became even more divided on the issue of slavery. States in the South still practiced slavery, while many states in the North prohibited slavery. As a result, many slaves tried to run away to freedom in North. The Underground Railroad was established to provide a secret way for slaves to escape from slavery in the South to freedom in the North. As you read, take notes on how the Underground Railroad helped slaves to freedom in the North.

[1] Any cause needs speakers and organizers. Any mass movement requires men and women of great ideas.

But information and mobilization are not enough. To be successful, revolutionary change requires people of action — those who little by little chip away at the forces who stand in the way. Such were the “conductors” of the Underground Railroad. Not content¹ to wait for laws to change or for slavery to implode itself,² railroad activists helped individual fugitive slaves³ find the light of freedom. The Underground Railroad was not an actual railroad, but was instead a network of safe houses and routes slaves could take to escape from the South to freedom in the North.

The Underground Railroad operated at night. Slaves were moved from “station” to “station” by abolitionists.⁴ These “stations” were usually homes and churches — any safe place to rest and eat before continuing on the journey to freedom in the North, sometimes as far away as Canada. Often whites would pretend to be the masters of fugitives to prevent their capture. Sometimes lighter-skinned African Americans took this role. In one spectacular case, Henry “Box” Brown arranged for a friend to put him in a wooden box, where he had only a few biscuits and some water. His friend mailed him to the North, where bemused⁵ abolitionists received him in Philadelphia.



"Harriet Tubman" by H. Seymour Squyer is in the public domain.

1. **Content (adjective):** in a state of peace, happiness, or satisfaction
2. “Implode” in this sense means to self-destruct.
3. A fugitive slave was someone who ran away from the slave owner and went into hiding to avoid being taken back.
4. Abolitionism was a movement to “abolish,” or end, slavery.
5. **Bemused (adjective):** confused and also somewhat amused

Most of the time, however, slaves crept northward on their own, looking for the signal that designated the next safe haven.⁶ This was indeed risky business, because slave catchers and sheriffs were constantly on the lookout. Over 3,200 people are known to have worked on the railroad between 1830 and the end of the Civil War. Many will remain forever anonymous.⁷

- [5] Perhaps the most outstanding “conductor” of the Underground Railroad was Harriet Tubman. Born a slave herself, after she escaped to Philadelphia, she began working on the railroad to free her family members. Throughout the 1850s, Tubman made 19 separate trips into slave territory. She was terribly serious about her mission. She threatened to shoot any slave who had second thoughts with the pistol she carried on her hip. By the end of the decade, she was responsible for freeing about 300 slaves. When the Civil War broke out, she used her knowledge from working the railroad to serve as a spy for the Union.

Needless to say, slave owners did not appreciate the Underground Railroad. Although they disliked Abolitionist talk and literature, the railroad was far worse. To them, these were simple cases of stolen property. Slave catchers often traveled to the North to try to recapture freed slaves. When Northerners rallied around freed slaves and refused to compensate⁸ former slave owners, Southerners felt they were being robbed of property.

This disagreement over freed slaves lay yet another brick of the foundation for the South to eventually secede⁹ from the Union and help spark the American Civil War.

“The Underground Railroad” by USHistory.org. Copyright © 2016, CC BY 4.0. Reprinted with permission, all rights reserved.

6. **Haven** (*noun*): a place of safety

7. **Anonymous** (*adjective*): not named or identified

8. **Compensate** (*verb*): to trade or give money as payment for something lost, stolen, or damaged

9. "Secede" refers to the South's decision to leave the Union at the start of the American Civil War.

Text-Dependent Questions

Directions: For the following questions, choose the best answer or respond in complete sentences.

1. Why does the author choose to call the individuals who worked on the Underground Railroad “conductors”?
 - A. They were responsible for driving the trains that took slaves from slavery in the South to freedom in the North.
 - B. Even though it was not an actual railroad, the “conductors” were individuals responsible for helping slaves travel from the South to the North.
 - C. They conducted trains and boats that took fugitive slaves back to their masters in the South.
 - D. They carried pistols on their hips that were known by people in the North as “conductors.”

2. Which phrase from the text does the author use to support their argument that a wide variety of people worked for the Underground Railroad?
 - A. “Railroad activists helped individual fugitive slaves find the light of freedom.” (Paragraph 2)
 - B. “Often whites would pretend to be the masters of fugitives to prevent their capture. Sometimes lighter-skinned African Americans took this role.” (Paragraph 3)
 - C. “Most of the time, however, slaves crept Northward on their own, looking for the signal that designated the next safe haven.” (Paragraph 4)
 - D. “Perhaps the most outstanding ‘conductor’ of the Underground Railroad was Harriet Tubman.” (Paragraph 5)

3. How does paragraph 5 contribute to the ideas developed throughout the text?
 - A. The paragraph provides an example of a famous train conductor who shipped pistols to the North to help them win the war.
 - B. The paragraph is used to show that Harriet Tubman is the only true hero of the Underground Railroad.
 - C. The paragraph is used to provide an example of a famous woman who worked on the Underground Railroad and the great impact she had on history.
 - D. The paragraph is used to demonstrate that most of the slaves that escaped to the North were shipped to the North on boxes in trains.

4. Which phrase best describes the relationship between slave catchers and the “conductors” of the Underground Railroad?
 - A. They worked together towards a common goal.
 - B. They were united in trying to provoke a war.
 - C. They were in disagreement about the value of property.
 - D. They represent the opposite sides of the conflict.

5. What is the central idea of the text? Cite specific evidence from the text to support your answer.

Name: _____ Class: _____ Date: _____

Pairing Questions for "Theseus and the Minotaur" and "The Underground Railroad"

Directions: After reading the texts, choose the best answer for the multiple-choice questions below and respond to the writing questions in complete sentences.

1. PART A: Which of the following qualities led to Theseus' and Harriet Tubman's successes? [RI.3, RL.3]
 - A. bravery in the face of danger
 - B. patience despite pressure
 - C. tolerance of others who think differently from them
 - D. knowledge of their enemies

2. PART B: Select TWO quotations that best support the answer to Part A. [RI.1, RL.1]
 - A. "Theseus insisted that he understood the dangers but would succeed. 'I will return to you, father,' cried Theseus, as the ship left the harbour wall, 'and you will be proud of your son.'" ("Theseus and the Minotaur," Paragraph 9)
 - B. "Then I wish you good luck, my son,' cried his father, 'I shall keep watch for you every day. If you are successful, take down these black sails and replace them with white ones. That way I will know you are coming home safe to me.'" ("Theseus and the Minotaur," Paragraph 10)
 - C. "Theseus walked carefully through the dark, foul-smelling passages of the labyrinth, expecting at any moment to come face-to-face with the creature." ("Theseus and the Minotaur," Paragraph 19)
 - D. "This was indeed risky business, because slave catchers and sheriffs were constantly on the lookout." ("The Underground Railroad," Paragraph 5)
 - E. "She threatened to shoot any slave who had second thoughts with the pistol she carried on her hip." ("The Underground Railroad," Paragraph 5)
 - F. "When the Civil War broke out, she used her knowledge from working the railroad to serve as a spy for the Union." ("The Underground Railroad," Paragraph 5)

3. What motivations do Theseus and Harriet Tubman share? [RI.3, RL.3]

Unit 4

Lesson: Parallelism

Learning Targets

- Demonstrate command of the conventions of standard English grammar and usage when writing or speaking.
- Use a comma to separate coordinate adjectives.

Parallelism

You can use **parallelism**, the use of similar grammatical forms or sentence structures, to balance related ideas. Using parallelism helps readers and listeners understand that ideas are of similar importance. Parallelism can also make your writing and speech more interesting.

parallel words	The wet, bedraggled, muddy boys needed baths and sleep. <i>[parallel coordinate adjectives]</i>
parallel phrases	We are studying biology, social studies, and algebra . <i>[parallel nouns]</i> Olivia is out of patience and in a hurry . <i>[parallel prepositional phrases]</i> Sierra wants to study the problem, discuss our options, and propose a solution . <i>[parallel infinitive phrases]</i>
parallel clauses	The horse reared, the crows called, and the bats flew . <i>[parallel independent clauses]</i> After the morning team paints the outside walls and before the afternoon team paints the inside walls , someone needs to clean the brushes. <i>[parallel dependent clauses]</i>

Coordinate Elements

The parallel items in the examples above can also be called **coordinate** grammatical elements. In each sentence, the elements are of similar importance and share the same grammatical form. Commas should be used to separate them, and a coordinating conjunction may be used to join them:

wet, bedraggled, muddy boys OR **wet, bedraggled, and muddy** boys

Check Your Understanding: Correcting Parallel Structure

Each of the following sentences has nonparallel structures. Revise each sentence to make it parallel.

1. On the seashore, I saw shells, litter, and that there were seabirds.
2. You can pay by credit card, cash, or writing a check.
3. He said they were late because they overslept, they were disorganized, and the weather.
4. I prefer to use context clues or if you can look up the words.
5. To wink is to close one eye, while to blink is when you close both.

7th Grade Week 2 Writing: Provide a Conclusion

Directions: *Read* the prompt below, and then *read and analyze* the text titled “Student Sample: Grade 7”. Use the Graphic Organizer to *take notes on the* argument and the strength of the conclusion, and then follow the directions in the prompt to *write* your new conclusion paragraph including a call to action .

▼ Prompt

In this scored Student Sample, the writer argues that his or her school should participate in the national “Shut Down Your Screen Week” in which no electronic devices are used for one week. The student received a high score for writing, but reviewers felt that the concluding paragraph was lacking additional support for the argument. Write a New Concluding Paragraph for this letter. Be sure that your paragraph effectively summarizes the argument presented and adds support to it. End with a thought-provoking idea that urges readers to take action.

1. **Read** and analyze the Student Sample, taking notes on the argument presented and evaluating the strength of the conclusion.
2. **Plan** a New Concluding Paragraph that improves on the original.
3. **Write** your New Concluding Paragraph, ending with a call to action.



Video Link

Optional: Add a video link...

Student Sample: Grade 7

This Persuasive Letter was written by a seventh-grade student. The prompt asked students to take a position on whether their school should participate in the national "Shut Down Your Screen Week."



Dear Teachers,

I have recently begun learning about the "Shut Down Your Screen" week. This is a program where kids in school and out of school don't use any electronics for one week. Everyone in your school would participate. This is a way to save the way we think and try something new. My question is should we participate in the national "Shut Down Your Screen Week?" I think it would be a good idea for many reasons.

First, I think we should participate because using too much technology affects the way we think and behave. In the article *Attached to Technology and Paying a Price* by Matt Richtel it gives many scientifically proven facts that using technology too much affects the way we think.

If you are juggling e-mail, phone calls and other incoming information it can lose people's focus. Also as the text states, "The stimulation provokes excitement that researchers say can be addictive. In its absence, people feel bored." This means that people can become addicted and when not using technology become bored with things they used to love to do.

Another reason I think we should participate in this program is because using technology while doing something else (multitasking) really just creates more trouble focusing. Scientists did an experiment where they took someone that multitasks and someone that doesn't. It was proven that even though the multitasker multitasks more, they did a worse job than the other person. Therefore technology and multi-tasking does nothing for you.



Another reason I think we should participate is it puts a bad toll on children. Some people may say that playing a video game or watching a movie with your family helps to bond with family. That may be true, but you can get addicted and not want to do anything else. "Lily, a second grader, is allowed only an hour a day of unstructured time, which she often spends with her devices." This shows that kids are playing on devices and not outside or with friends. If we participate, we, the kids, can do other things and be more social.

Therefore, I think we should participate in the "Shut Down Your Screen Week." Thank you for your time.

Sincerely, _____

Demonstrate Comprehension

Use this chart to review the Student Sample. Then evaluate the writer's conclusion. Copy the information from the text and paste it below. Or answer the questions in your own words.

What is the writer's claim?	
What reasons and evidence does the writer use to support the claim?	
What does the conclusion do well?	Does the conclusion follow from the argument presented, support the argument, summarize the argument, and/or leave readers with something to think about?
What could the conclusion do better?	Could the conclusion improve how it follows the argument presented, supports the argument, summarizes the argument, and/or leaves readers with something to think about?

Plan Your New Concluding Paragraph

Use this chart to plan your New Concluding Paragraph. When you are finished, use your answers to help you write your paragraph.

Summary: Restate the claim and summarize the main points.	How would you summarize the argument?
Additional Support: Give additional reasons from your life or your prior knowledge.	What additional support can you provide?
Final Thought: Urge readers to take action or consider an important question.	What thought-provoking idea or question can you leave readers with?

Areas of Composite Figures

You can break a **composite figure** into shapes that you know. Then use those shapes to find the area.

$$A (\text{rectangle}) = 9 \cdot 6 = 54 \text{ m}^2$$

$$A (\text{square}) = 3 \cdot 3 = 9 \text{ m}^2$$

$$A (\text{composite figure}) \\ = 54 + 9 = 63 \text{ m}^2$$

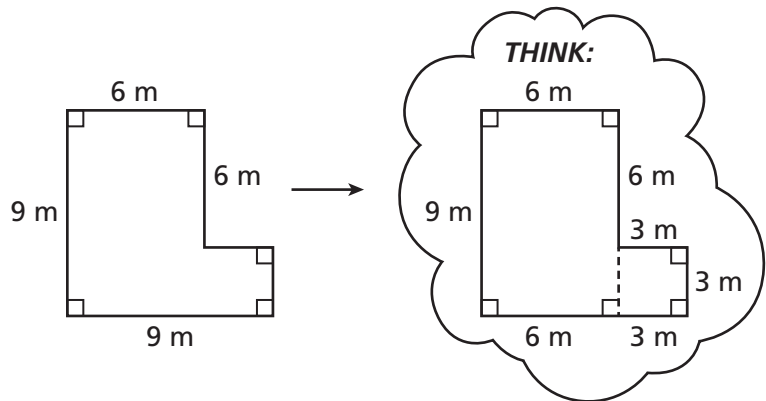

Find the area of the composite figure.

A. Find the area of the rectangle.

$$A (\text{rectangle}) = 4 \cdot 8 = 32 \text{ ft}^2$$

B. Find the area of the triangle.

$$A (\text{triangle}) = \frac{1}{2} \cdot 6 \cdot 2 = 6 \text{ ft}^2$$

C. Add the area of each shape to find the area of the composite figure.

$$A (\text{composite figure}) = 32 + 6 = 38 \text{ ft}^2$$

The area of the composite figure is 38 ft^2 .

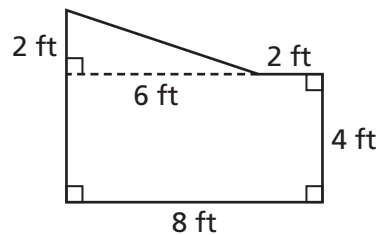

Find the area of each composite figure.

1.

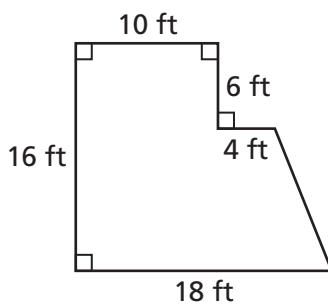

2.

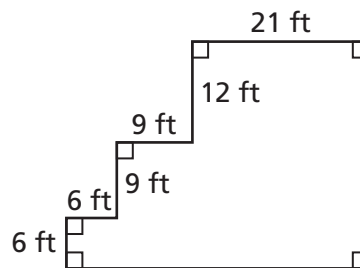

Area of Composite Figures

1. Paul designed a lamp using grid paper. What is the area of the drawing of the lamp?

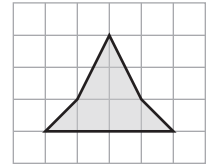

2. Martha is building a deck. She sketches a plan for the deck. What will its area be? Round to the nearest tenth.

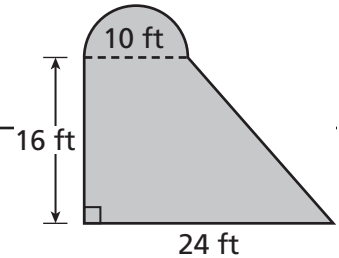

For Problems 3–6, find the area. Round to the nearest tenth, if necessary.

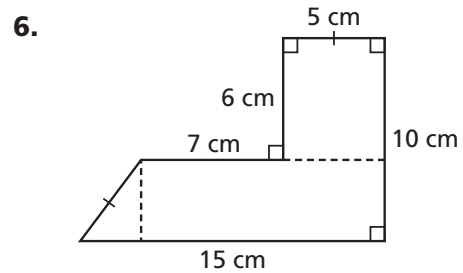
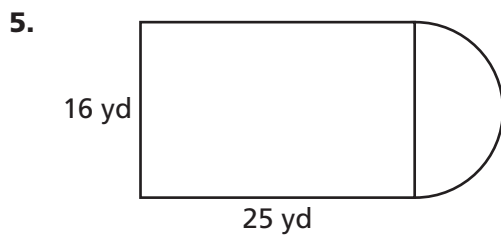
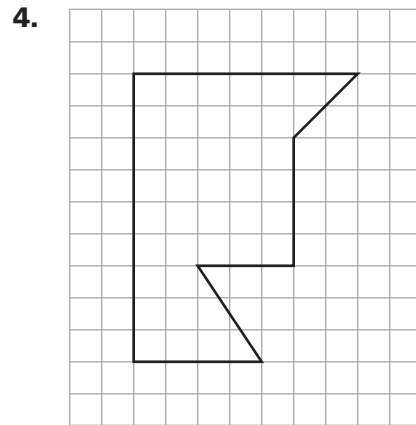
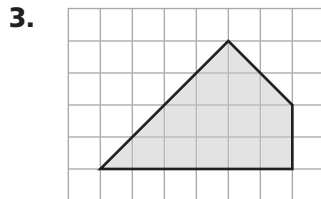

Describe and Analyze Cross Sections of Prisms and Pyramids

A **cross section** is a two-dimensional figure formed by the intersection of a plane and a solid.

The shape of the cross section depends on whether the plane intersects with the solid parallel or perpendicular to the base of the solid. For example, a perpendicular cross section of a square pyramid through the vertex is shaped like a triangle, while the cross section is either a triangle or a trapezoid if it does not go through the vertex. A cross section parallel to the base of a pyramid is shaped like a square.

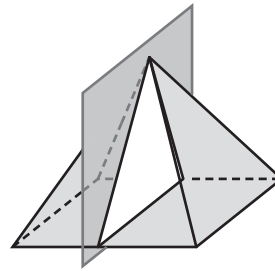

perpendicular

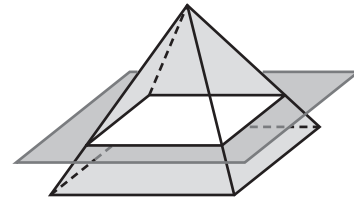

parallel

The bases of a prism are polygons. A prism is a right prism when the faces that connect the bases are perpendicular to the bases. A cross section parallel to the bases of a right prism will always have the shape of the polygon. A cross section perpendicular to the bases of a right prism will always have the shape of a rectangle.

The bases of a prism are polygons. A prism is a right prism when the faces that connect the bases are perpendicular to the bases. A cross section parallel to the bases of a right prism will always have the shape of the polygon. A cross section perpendicular to the bases of a right prism will always have the shape of a rectangle.

Find the shape of the cross sections parallel and perpendicular to the base of a right triangular prism.

- A.** Identify the shape of a cross section parallel to the base.

Because the three-dimensional shape is a right triangular prism, the shape of a cross section parallel to the base is a triangle.

- B.** Identify the shape of a cross section perpendicular to the base.

Because the three-dimensional shape is a right prism, the shape of a cross section perpendicular to the base is a rectangle.

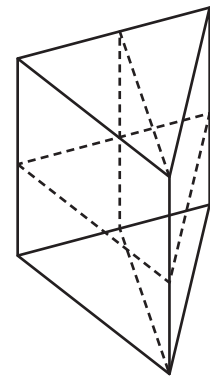

Identify the shape of the cross sections parallel and perpendicular to the base for each three-dimensional figure.

<p>1. right octagonal prism</p> <p>parallel:</p> <p>_____</p> <p>perpendicular:</p> <p>_____</p>	<p>2. right pentagonal prism</p> <p>parallel:</p> <p>_____</p> <p>perpendicular:</p> <p>_____</p>	<p>3. right hexagonal prism</p> <p>parallel:</p> <p>_____</p> <p>perpendicular:</p> <p>_____</p>
---	--	---

Derive and Apply Formulas for Surface Area of Cubes and Right Prisms

The **surface area** of a three-dimensional figure is the combined areas of the faces. You can find the surface area of a prism by drawing a net of the flattened figure.

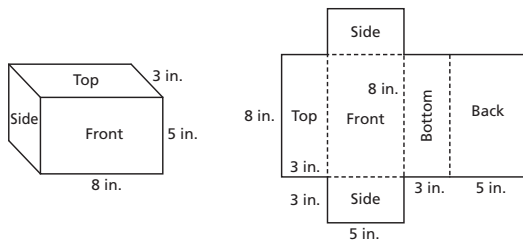

Find the surface area of the triangular prism.

- Make a net of the triangular prism. Label the given dimensions on the net.
- Use the net to determine the area of each face of the triangular prism.

$$2 \text{ triangular sides} - 2 \times \left(\frac{1}{2} \times 8 \times 3 \right) = 24 \text{ cm}^2$$

$$2 \text{ rectangular sides} - 2 \times (12 \times 3) = 72 \text{ cm}^2$$

$$1 \text{ rectangular base} - 8 \times 12 = 96 \text{ cm}^2$$

- Add the areas of the faces to find the total surface area.

$$24 \text{ cm}^2 + 72 \text{ cm}^2 + 96 \text{ cm}^2 = 192 \text{ cm}^2$$

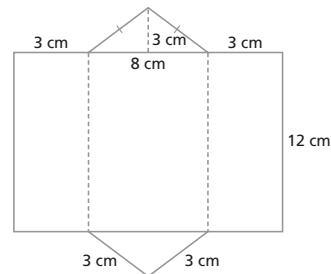
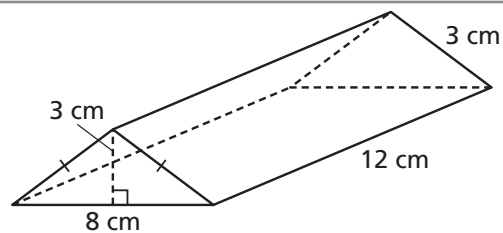

Find the surface area of each of the figures shown.

1.

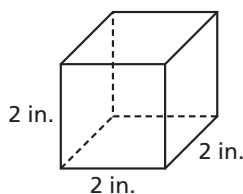

2.

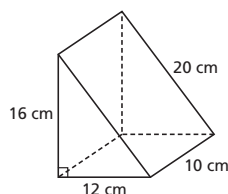

3.

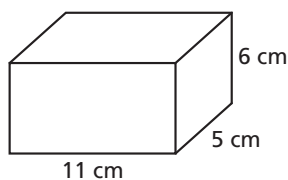

4.

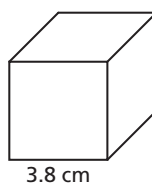

Volume of Rectangular Prisms

Review Problems from cK-12

The volume of the rectangular prism is a function of multiplying the length \times the width \times the height.

Find the volume of each rectangular prism. Remember to label your answer in cubic units.

1. Length = 5 in, width = 3 in, height = 4 in
2. Length = 7 m, width = 6 m, height = 5 m
3. Length = 8 cm, width = 4 cm, height = 9 cm
4. Length = 8 cm, width = 4 cm, height = 12 cm
5. Length = 10 ft, width = 5 ft, height = 6 ft
6. Length = 9 m, width = 8 m, height = 11 m
7. Length = 5.5 in, width = 3 in, height = 5 in
8. Length = 6.6 cm, width = 5 cm, height = 7 cm
9. Length = 7 ft, width = 4 ft, height = 6 ft
10. Length = 15 m, width = 8 m, height = 10 m
11. Length = 10.5 m, width = 11 m, height = 4 m
12. Length = 12 ft, width = 12 ft, height = 8 ft
13. Length = 16 in, width = 8 in, height = 8 in
14. Length = 12 m, width = 12 m, height = 12 m
15. Length = 24 in, width = 6 in, height = 6 in

Water and Its Properties

Choose the letter of the best answer.

1. The circle graph below shows the distribution of water and land on Earth.

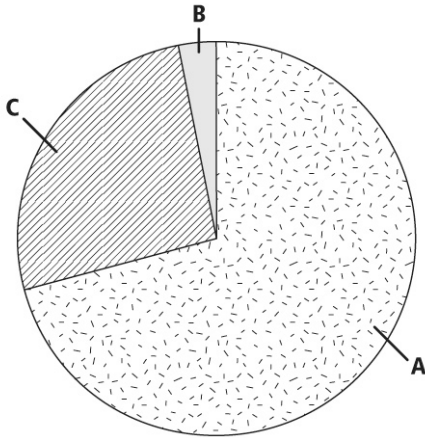

Which statement best explains the graph?

- A. A is land, B is fresh water, and C is salt water
 B. A is salt water, B is fresh water, and C is land
 C. A is fresh water, B is land, and C is salt water
 D. A is salt water, B is land, and C is fresh water
2. Which of the following is an example of cohesion?
- A. water transforming into vapor
 B. water soaking into a paper towel
 C. water slowly dissolving rocks over time
 D. water forming droplets during a rainstorm
3. A water molecule contains two hydrogen atoms and one oxygen atom. Which of the following statements about water molecules is true?
- A. All of the atoms have a positive charge.
 B. All of the atoms have a negative charge.
 C. The oxygen atom is positively charged and the hydrogen atoms are negatively charged.
 D. The oxygen atom is negatively charged and the hydrogen atoms are positively charged.

4. Which of the following best describes the relationship between developing nations, clean water, and human health?
- A. Many developing nations lack access to clean water; this can harm human health.
 B. Clean water is never available in developing nations, so human health is always a major issue there.
 C. Human health does not depend on clean water; health issues in developing nations are not related to water.
 D. Contaminated water and human health is not a problem in developing nations, but it is a problem in developed nations.
5. Why does solid water (ice) float when placed in liquid water?
- A. Ice does not float in liquid water.
 B. Ice is less dense than liquid water.
 C. Ice is more dense than liquid water.
 D. The densities of liquid water and ice are the same.

Ocean Currents

Choose the letter of the best answer.

- Which three factors most directly affect surface currents in the oceans?
 - upwelling, convection, and the sun's energy
 - deep currents, convection currents, and surface winds
 - dissolved solids, dissolved gases, and the sun's energy
 - surface winds, the Coriolis effect, and continental deflection
- Carly draws a map of surface currents in the Atlantic Ocean. On her map, she includes the major wind belts for the same area. Her map is similar to the one shown.

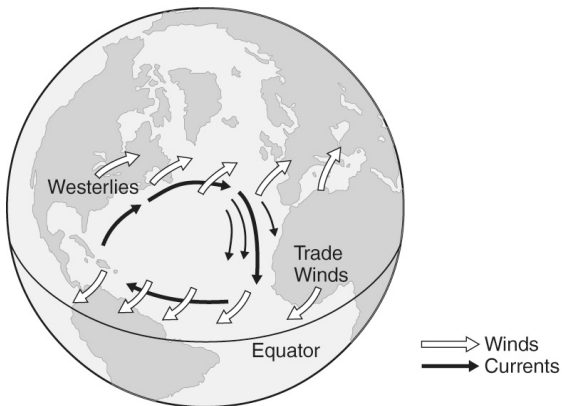

If Carly wants to add wind belts for the part of the Atlantic just south of the equator, how should she draw the arrows?

- The arrows should curve upward to the left.
- The arrows should curve upward to the right.
- The arrows should curve downward to the left.
- The arrows should curve downward to the right.

- How does convection cause ocean currents?
 - During the process of convection, energy is transferred to the atmosphere, forming winds. These winds power surface currents.
 - During the process of convection, the heating of surface water by the sun results in upwelling.
 - During the process of convection, water that was warmed by the sun loses heat. The water cools, becomes denser, and sinks.
 - During the process of convection, more minerals and gases dissolve in warm water. This increases the density of the warm water and causes it to sink.
- Which of the following can cause an increase in density that results in a deep ocean current?
 - The sun heats the water's surface.
 - A warm wind blows across cold water.
 - An iceberg melts, adding fresh water to ocean water.
 - Warm water loses energy to its surroundings and cools.
- Which of the following movements of ocean water has the greatest direct effect on the growth of producers?
 - upwelling
 - deep current
 - surface current
 - convection current

Human Impact on Water

Mix and Match: *Water Pollution*

Mix and match ideas to show what you've learned about how people affect our water supply.

1. Choose one source of pollution from Column A, two topics from Column B, and one option from Column C. Check your choices.
2. Be prepared to submit or present your results to your teacher when you return to school.

A. Choose One Pollution Source	B. Choose Six Things to Analyze	C. Choose One Way to Communicate Analysis
<input type="checkbox"/> acid rain <input type="checkbox"/> urbanization <input type="checkbox"/> dams <input type="checkbox"/> chemical spills <input type="checkbox"/> farm waste/sewage <input type="checkbox"/> oil refineries <input type="checkbox"/> plastics factories <input type="checkbox"/> fertilizer runoff <input type="checkbox"/> construction work <input type="checkbox"/> urban runoff <input type="checkbox"/> power plants <input type="checkbox"/> irrigation <input type="checkbox"/> human activity	<input type="checkbox"/> drinkability of water <input type="checkbox"/> effect on rivers and lakes <input type="checkbox"/> effect on aquifers <input type="checkbox"/> effect on ground water <input type="checkbox"/> effect on surface water <input type="checkbox"/> effect on reservoirs <input type="checkbox"/> effect on oceans <input type="checkbox"/> effect on water temperature <input type="checkbox"/> effect on the supply of fresh water <input type="checkbox"/> effect on measures of water quality	<input type="checkbox"/> diagram or illustration <input type="checkbox"/> model <input type="checkbox"/> drawings or descriptions <input type="checkbox"/> booklet <input type="checkbox"/> game <input type="checkbox"/> story, song, or poem, with supporting details <input type="checkbox"/> skit, chant, or dance, with supporting details <input type="checkbox"/> multimedia presentation <input type="checkbox"/> mathematical explanation <input type="checkbox"/> flowchart <input type="checkbox"/> timeline

Human Impact on Water

Choose the letter of the best answer.

1. The line graph below shows the average amount of dissolved nutrients in a body of water each year from 1998 to 2003.

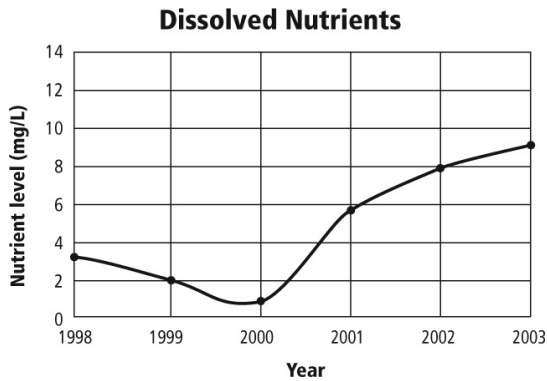

Which human activity most likely affected this body of water between 2000 and 2003?

- A. burning fossil fuels
 B. dumping litter in the water
 C. adding chemical fertilizers to water
 D. discharging warm water into the body of water
2. Over the course of many years, a rural farm town becomes more urban. Which of the following will most likely happen in the town as a result of this urbanization?
- A. The amount of rainfall will increase.
 B. Rivers may be contaminated by sewage.
 C. Light pollution in the town may decrease.
 D. People will develop more farms in the town.

3. Humans need fresh, clean water to survive. Which of these statements is true about fresh water?
- A. An unlimited amount of fresh water is available on Earth.
 B. In some places on Earth, fresh water is being used up faster than it can be replaced.
 C. The global population is currently decreasing, and people are using less fresh water.
 D. Fresh water was once considered a renewable resource, but today it is considered an inexhaustible resource.
4. One measure of water quality is the cloudiness of the water. Which of these terms describes this measure?
- A. pH
 B. potable
 C. turbidity
 D. temperature
5. The town of Winchester recently built an artificial body of water. This reservoir will store drinking water for the town. Which of the following could cause contamination of the water and lead to human health-related problems and loss of native species?
- A. development of a water quality plan
 B. building a fence around the reservoir
 C. improvements to a water treatment facility
 D. increased use of fertilizer to keep the vegetation growing

Day One—Read the text below and complete the Symbol and Metaphor Handout

Political Cartoons

Political cartoons are expressions of opinions that use all sorts of emotional appeals and other techniques to persuade others to accept those opinions. Most political cartoons are created to highlight problems or defend a political position. They cannot be treated as evidence either of the way things actually are or how everyone else feels about the subject of the cartoon. They are only a point of view, often a heavily biased point of view. Political cartoons use the following to express the viewpoint of the cartoonist: symbolism, exaggeration, labeling, analogy and irony.

Symbolism -- an illustration to represent the issue

Exaggeration—body parts are overdone to make a point

Labeling—write text to make sure that the reader understands what the symbol represents

Analogy—a comparison between unlike things (person, objects)

Irony—the difference between what things are and what they should be

<https://www.youtube.com/watch?v=BNkJNNuxsuQ>

[https://www.teachinghistory.org/sites/default/files/2018-08/Political Cartoon Docs 1-3 1.pd](https://www.teachinghistory.org/sites/default/files/2018-08/Political%20Cartoon%20Docs%201-3%201.pdf)

Day One—Read the text below and complete the Symbol and Metaphor Handout

Political Cartoons

Political cartoons are expressions of opinions that use all sorts of emotional appeals and other techniques to persuade others to accept those opinions. Most political cartoons are created to highlight problems or defend a political position. They cannot be treated as evidence either of the way things actually are or how everyone else feels about the subject of the cartoon. They are only a point of view, often a heavily biased point of view. Political cartoons use the following to express the viewpoint of the cartoonist: symbolism, exaggeration, labeling, analogy and irony.

Symbolism -- an illustration to represent the issue

Exaggeration—body parts are overdone to make a point

Labeling—write text to make sure that the reader understands what the symbol represents

Analogy—a comparison between unlike things (person, objects)

Irony—the difference between what things are and what they should be

<https://www.youtube.com/watch?v=BNkJNNuxsuQ>

[https://www.teachinghistory.org/sites/default/files/2018-08/Political Cartoon Docs 1-3 1.pd](https://www.teachinghistory.org/sites/default/files/2018-08/Political%20Cartoon%20Docs%201-3%201.pdf)

Sample Lesson – Handout 1 Symbol and Metaphor

The Cartoon: This cartoon on the drive for women’s suffrage appeared along with an article in the magazine *Judge*, March 3, 1917. The cartoon shows four women backing the drive for female suffrage riding on a steamroller crushing rocks labeled "opposition."

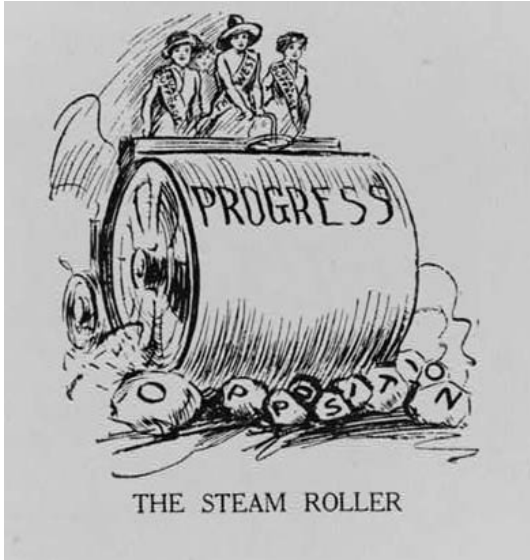

Library of Congress, Prints and Photographs Division,
LC-USZ62-128029

Background: By March of 1917, an energized women’s suffrage movement was in the last stages of its push to win the right to vote for all women in the United States. Women began winning voting rights in some western states in the late 1800s. The reform movement known as “Progressivism” further boosted the drive for female suffrage in the early 1900s. The effective roles women played during World War I may have finally pushed President Woodrow Wilson in 1917 to agree to back a Constitutional amendment guaranteeing women the right to vote. The 19th amendment was passed in 1919 and sent to the states. The states ratified it in 1920.

Checklist Item – Symbol and Metaphor in Cartoons: A visual symbol in a cartoon is any image that stands for some other thing, event, person, abstract idea or trend in the news. For example, a dollar sign may stand for the entire economy. An octopus may stand for a powerful corporation with “tentacles” controlling many other institutions. Metaphors are like symbols in that they describe one thing as something else entirely. Shakespeare used a metaphor when he wrote “All the world’s a stage.” (A cartoon would simply show the world as a stage.)

- Begin any cartoon analysis by describing all the details in it that are symbols and metaphors.

Source: <http://teachinghistory.org/teaching-materials/teaching-guides/21733>

Handout 1: Cartoon Analysis Worksheet

(Take brief notes to use in a class discussion)

1. What is this cartoon about?

(a one sentence summary of its main point)

2. What elements in the cartoon can be called symbols?

3. How are these symbols drawn? Are they drawn in specific ways that add to the point the cartoon makes? Why or why not?

4. What other objects might have been used instead of a steamroller and the rubble it is crushing?

5. Notice how the three women are drawn. Are these figures also symbols? Why or why not?

6. Why is one woman wearing a banner labeled "West"?

7. How might an opponent of this cartoon's point of view have altered the symbols in it?

Source: <http://teachinghistory.org/teaching-materials/teaching-guides/21733>

Sample Lesson – Handout 2 Visual Distortion

The Cartoon: The Library of Congress records no exact date or location for this cartoon on child labor by artist Herbert Johnson. It is a part of a collection attributed to photographer Lewis Hine. Based on photos near it, it is dated to approximately 1912.



Library of Congress, Prints and Photographs Division,
LC-DIG-nclc-04783

Background: Child labor existed throughout American history. As the nation industrialized, child labor moved from the farm to the factory. Children were seen as cheaper and easy to control. They were hired in large numbers to work in mines and factories, often in extremely unhealthy and dangerous conditions. In the early 1900s, labor unions and other national reform organizations began to seek legislation regulating or limiting child labor and promoting free, compulsory education as a substitute.

Checklist Item – Visual Distortion: Changes or exaggerations in size, shape, emotions or gestures often add extra meaning to the symbols the cartoon includes. For example, a dragon is often used as a symbol for China. But a huge, snorting dragon will make a different point about China from a tired, limping, meek dragon. Every detail in a cartoon, especially one that is distorted in some way, is likely to be a part of the cartoon's meaning.

- Identify the cartoon's symbols and notice how they are drawn.

Source: <http://teachinghistory.org/teaching-materials/teaching-guides/21733>

Handout 2: Cartoon Analysis Worksheet

(Take brief notes to use in a class discussion)

1. What big problem is this cartoon concerned with?

(a one sentence summary of its main point)

2. What are the key symbols in the cartoon and how are they distorted?

3. How do the distortions help the cartoon make its point?

4. Is there anything else about this huge hand besides its size that helps the cartoon make its point?

5. How are the children in the cartoon drawn? How does this add to the visual effect of the huge hand in the cartoon?

6. What else besides a hand might the artist have used to create an effective cartoon on this topic?

7. How might an opponent of this cartoon's point of view have altered the symbols in it or changed the way these symbols are distorted?

Source: <http://teachinghistory.org/teaching-materials/teaching-guides/21733>

Sample Lesson – Handout 3 Irony in Words and Images

The Cartoon: This cartoon on the evils of political patronage is by one of America’s most famous cartoonists, Thomas Nast. It appeared in *Harper’s Weekly*, April 28, 1877.



Library of Congress, Prints and Photographs Division,
LC-USZ62-89864

Background: This cartoon shows a statue of Andrew Jackson on pig. The statue is titled “To the Victors Belong the Spoils,” a phrase used to explain why election winners were entitled to hand out government jobs (patronage) to their loyal followers. Jackson was president from 1829-1837. However, Thomas Nast drew the cartoon in 1877, when he was battling machine politicians in New York City who in his view had proved how corrupt the patronage principle “to the victors belong the spoils” really was.

Checklist Item – Irony in Words and Images: Irony is a form of humor in which something is said in a way that undercuts or mocks its own apparent meaning. In other words, what is said seems to mean one thing, but it will be taken to mean the opposite. Irony is well suited to political cartoons, which often seek to mock something and show how false, unfair or dangerous it is. Irony always entails a contradiction. Often, an amusing image undercuts and reverses the meaning of the words in a caption. Sometimes, however, the image alone conveys the double meaning.

- Consider whether irony is used and if so, how?

Source: <http://teachinghistory.org/teaching-materials/teaching-guides/21733>

Handout 3: Cartoon Analysis Worksheet

(Take brief notes to use in a class discussion)

1. **This cartoon makes fun of one aspect of politics in the 1800s. Can you explain?** (a one sentence summary of its main point)

2. **In what ways does this image of a statue remind you of monuments dedicated to great or heroic figures?**

3. **Using your background knowledge, explain the term "To the Victors Belong the Spoils" in your own words.**

4. **What visual symbols in this cartoon undercut or go against the idea that this statue is meant to be heroic or admirable?**

5. **The pig on this statue is rooting around in some garbage labeled "fraud," "bribery," "spoils" and "plunder." How does this add to the ironic message of the cartoon?**

Source: <http://teachinghistory.org/teaching-materials/teaching-guides/21733>

Day Four-- Read the following editorial in favor of social distancing. Do you agree with the article? Explain your answer.

Social Distancing Required, Emotional Connections Needed

Grade 6-8 Art & Music Week 2 D 1-4

Art M-W

Free draw/paint/build—use the materials available to you—pen, pencil, apps, paint, clay, recyclables—it is up to you. Create something new from imagination, or take inspiration from objects you see every day.

Music T-Th

Listen to a piece of music-suggested music style for week 2: Blues--and take time to reflect on how this music makes you feel. Ask a friend or family member for suggestions. Reflect on how this new music makes you feel. Do you like it? Why or why not?

21 essential Blues songs link:

https://www.youtube.com/playlist?list=PLEFgBdod0r3QohHYbG2no75_ETtkQ2qW

Once weekly for art and music

Use the online music and art resource guides you received to virtually visit a museum or attend a concert. Practice good audience behavior. Reflect on your experience.

Art

1. What do you notice?
2. What do you think the artists intended?

Music

1. How did the music make you feel?
2. What do you think the artist intended?

Suggested Art: Dorthea Lange, MoMA NY <https://www.moma.org/artists/3373>

Suggested Music: B.B. King <https://www.pbs.org/video/austin-city-limits-bb-king/>

Photo Journal (as often as possible)

Materials: any camera (phone, tablet, regular camera, etc.)

Using a camera that you already have, take a daily image or set of images based on a theme, and use words to reflect on what the image means to you. Save all images and thoughts for a future share/presentation of your reflections of this time.

Week 2 theme: Sudden change

Perhaps you were going to visit family or take a vacation, or you are used to going to the park or a friend's house. Everything is different. Capture pictures with a camera that show how your world has changed and explain why with an artist's statement

An **artist's statement** is a written document that introduces you as an **artist**. It explains why and how you make your art, along with other facts about you and your art. ...**Artist's statements** typically **contain**: A few sentences on your personal relationship with art in general as well as why you do what you do, and thoughts on the art you created.

Quarantine Playlist

Curate your own playlist of music to use during the quarantine. Select songs to help you feel better when you are down, to get you up and moving, to represent your feelings (happiness, confusion, anger, love, etc.) Make a written reflection on why you selected the songs—there is no limit on how many you choose.

Online Music Resources for Students

McGraw-Hill Curriculum

GRADE LEVEL: K-5

WEBSITE: www.connected.mcgraw-hill.com

STUDENT USERNAME & PASSWORD: OHstudentsk5

Virtual Keyboard for computer or phone

GRADE LEVEL: All

WEBSITE: <https://www.onlinepianist.com/virtual-piano>

Free music tutorials for guitar, ukulele, voice, piano

GRADE LEVEL: 7-12

WEBSITE: <https://yousician.com/>

Rhythm Practice:

WEBSITE: <http://www.therhythmtrainer.com/>

Instruments of the Orchestra visual and aural identification:

WEBSITE: <http://www.musicgames.net/livegames/flyinginstruments/flyinginstruments1.htm>

Identify the notes on the treble clef staff:

WEBSITE: <http://musicteachersgames.com/trebleClefOne>

Various Music Activities Curated by CMSD's own Ms. Elardo

GRADE LEVEL: K-8

WEBSITE: <https://sites.google.com/site/musicroomtech/>

Rock & Roll Hall of Fame

GRADE LEVEL: K-12

WEBSITE: <https://edu.rockhall.com/>

Reflective essay on hip hop

GRADE LEVEL: 8-12

WEBSITE: <https://edu.rockhall.com/sites/default/files/2018-11/Hip%20Hop%20essay.pdf>

Online Music Resources for Teachers

McGraw-Hill Curriculum

GRADE LEVEL: K-5

WEBSITE: www.connected.mcgraw-hill.com

TEACHER USERNAME & PASSWORD: OHteachersk5

GRADE LEVEL: 6-12

WEBSITE: [Distance Learning & Music Studio](#)

HELP VIDEOS: [For teachers to give assignments](#) –AND- [For students to access content](#)

Online Visual Art Resources for Students

Live Drawing & Writing with Kennedy Center's Artist in Residence (weekdays at 1:00pm)

GRADE LEVEL: K-5

WEBSITE: https://www.kennedy-center.org/mowillems?fbclid=IwAR2STUDFsE424sGLY2gw2nl1vtd9jN7GZchwW9yahKh_UFuPuHdnJzdy-XU

ADDITIONAL (Printable) RESOURCES: <http://pigeonpresents.com/get-busy/>

Live Drawing & Illustration with Children's Book Author & Illustrator JJK (weekdays at 2:00pm)

GRADE LEVEL: K-12

WEBSITE: <https://www.youtube.com/channel/UCObbZ-lkhRQ203mtX9ZmgtA>

Wall Art & Poetry

GRADE LEVEL: K-3

WEBSITE: <https://kinderart.com/art-lessons/multic/a-box-of-crayons/>

Create Comics & Digital Paintings

GRADE LEVEL: 5-12

WEBSITE 1: <https://krita.org/en/>

WEBSITE 2: <https://medibangpaint.com/en/>

Drawing App

GRADE LEVEL: 8-12

WEBSITE: <https://sketchbook.com/education>

Virtual Museum Tours

GRADE LEVEL: ALL

WEBSITE 1: <https://www.louvre.fr/en/visites-en-ligne> (The Louvre - Paris, France)

WEBSITE 2: <https://www.metmuseum.org/art/online-features/met-360-project> (The Metropolitan Museum of Art – New York, NY)

WEBSITE 3: <http://www.museivaticani.va/content/museivaticani/en/collezioni/musei/cappella-sistina/tour-virtuale.html> (Sistine Chapel – Vatican City, Rome, Italy)

WEBSITE 4: https://artsandculture.google.com/streetview/solomon-r-guggenheim-museum-interior-streetview/jAHfbv3JGM2KaQ?hl=en&sv_lng=-73.95897540047744&sv_lat=40.78284373830581&sv_h=314.0433944528588&sv_p=-

[14.064051297192009&sv_pid=rfLOHTGWrOlcY4J1Oc_UzQ&sv_z=0.2739310462916821](https://www.guggenheim.org/new-york/exhibitions/14.064051297192009&sv_pid=rfLOHTGWrOlcY4J1Oc_UzQ&sv_z=0.2739310462916821)

(Guggenheim – New York, NY)

WEBSITE 5: <https://360stories.com/amsterdam/oldamsterdam/story/vincent-van-gogh> (Van Gogh Museum – Amsterdam, Netherlands)

WEBSITE 6: <https://www.thechinaguide.com/destination/great-wall-of-china> (Great Wall of China – Northern China)

WEBSITE 7: <https://naturalhistory.si.edu/visit/virtual-tour> (National Museum of Natural History – Washington, DC)

WEBSITE 8: <https://artsandculture.google.com/partner/moma-the-museum-of-modern-art> (Museum of Modern Art – New York, NY)

Games to Play with ONLY Pencil & Paper

GRADE LEVEL: K-12

WEBSITE: <https://raisingwonder.com/12-brain-boosting-pencil-and-paper-games/>

DIY Loom for Weaving

GRADE LEVEL: 3-12

WEBSITE: <https://www.brooklynraftcompany.com/blogs/news/how-to-make-a-diy-mini-loom-draft>

Online Visual Art Resources for Teachers

National Gallery of Art

GRADE LEVEL: K-12

WEBSITE: [Www.nga.gov](http://www.nga.gov)

Trash To Treasures Assemblage Art

GRADE LEVEL: 3-5

WEBSITE: https://www.incredibleart.org/lessons/elem/trash_treasures.html

Remote Teaching Resources

GRADE LEVEL:

WEBSITE: <https://www.artedguru.com/home/covid-19-remote-teaching-resources>

CMA's "open access" program

WEBSITE: <https://www.clevelandart.org/open-access>